

# MC33039

## Closed Loop Brushless Motor Adapter

The MC33039 is a high performance closed-loop speed control adapter specifically designed for use in brushless DC motor control systems. Implementation will allow precise speed regulation without the need for a magnetic or optical tachometer. This device contains three input buffers each with hysteresis for noise immunity, three digital edge detectors, a programmable monostable, and an internal shunt regulator. Also included is an inverter output for use in systems that require conversion of sensor phasing. Although this device is primarily intended for use with the MC33035 brushless motor controller, it can be used cost effectively in many other closed-loop speed control applications.

- Digital Detection of Each Input Transition for Improved Low Speed Motor Operation
- TTL Compatible Inputs With Hysteresis
- Operation Down to 5.5 V for Direct Powering from MC33035 Reference
- Internal Shunt Regulator Allows Operation from a Non-Regulated Voltage Source
- Inverter Output for Easy Conversion between 60°/300° and 120°/240° Sensor Phasing Conventions

### CLOSED LOOP BRUSHLESS MOTOR ADAPTER SEMICONDUCTOR TECHNICAL DATA

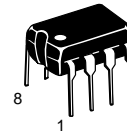

**P SUFFIX**  
PLASTIC PACKAGE  
CASE 626



**D SUFFIX**  
PLASTIC PACKAGE  
CASE 751  
(SO-8)

### Representative Block Diagram

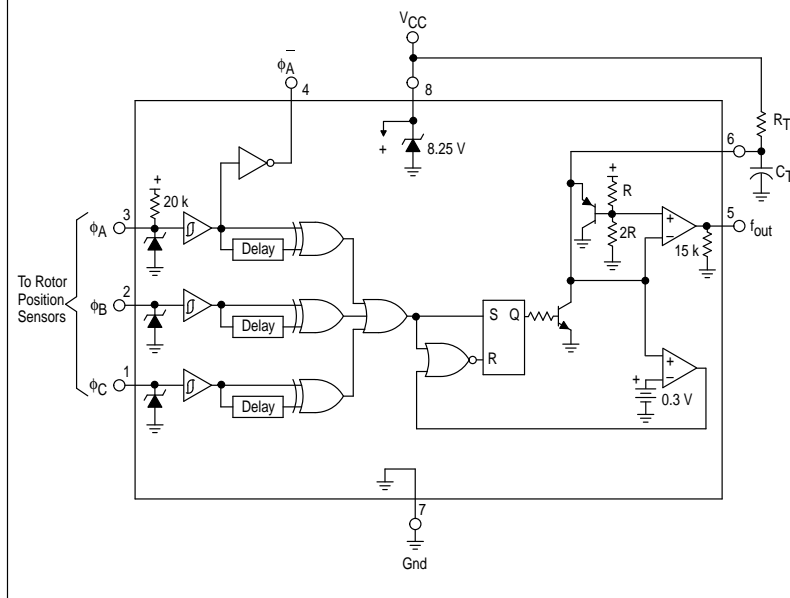

### PIN CONNECTIONS

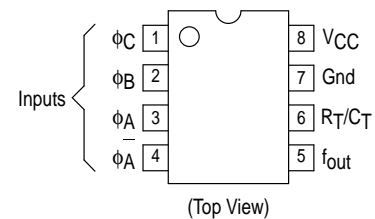

### ORDERING INFORMATION

Device	Operating Temperature Range	Package
MC33039D	$T_A = -40^\circ \text{ to } +85^\circ \text{C}$	SO-8
MC33039P		Plastic DIP

# MC33039

## MAXIMUM RATINGS

Rating	Symbol	Value	Unit
V <sub>CC</sub> Zener Current	I <sub>Z(V<sub>CC</sub>)</sub>	30	mA
Logic Input Current (Pins 1, 2, 3)	I <sub>IH</sub>	5.0	mA
Output Current (Pins 4, 5), Sink or Source	I <sub>DRV</sub>	20	mA
Power Dissipation and Thermal Characteristics Maximum Power Dissipation @ T <sub>A</sub> = + 85°C Thermal Resistance, Junction-to-Air	P <sub>D</sub> R <sub>θJA</sub>	650 100	mW °C/W
Operating Junction Temperature	T <sub>J</sub>	+ 150	°C
Operating Ambient Temperature Range	T <sub>A</sub>	- 40 to + 85	°C
Storage Temperature Range	T <sub>stg</sub>	- 65 to + 150	°C

## ELECTRICAL CHARACTERISTICS (V<sub>CC</sub> = 6.25 V, R<sub>T</sub> = 10 k, C<sub>T</sub> = 22 nF, T<sub>A</sub> = 25°C, unless otherwise noted)

Characteristic	Symbol	Min	Typ	Max	Unit
----------------	--------	-----	-----	-----	------

### LOGIC INPUTS

Input Threshold Voltage High State	V <sub>IH</sub>	2.4	2.1	—	V
Low State	V <sub>IL</sub>	—	1.4	1.0	
Hysteresis	V <sub>H</sub>	0.4	0.7	0.9	
Input Current High State (V <sub>IH</sub> = 5.0 V)	I <sub>IH</sub>	—	—	—	μA
φ <sub>A</sub>		- 40	- 60	- 80	
φ <sub>B</sub> , φ <sub>C</sub>		—	- 0.3	- 5.0	
Low State (V <sub>IL</sub> = 0 V)	I <sub>IL</sub>	—	—	—	
φ <sub>A</sub>		- 190	- 300	- 380	
φ <sub>B</sub> , φ <sub>C</sub>		—	- 0.3	- 5.0	

### MONOSTABLE AND OUTPUT SECTIONS

Output Voltage High State	V <sub>OH</sub>	—	—	—	V
f <sub>out</sub> (I <sub>source</sub> = 5.0 mA)		3.60	3.95	4.20	
φ <sub>A</sub> (I <sub>source</sub> = 2.0 mA)		4.20	4.75	—	
Low State	V <sub>OL</sub>	—	—	—	
f <sub>out</sub> (I <sub>sink</sub> = 10 mA)		—	0.25	0.50	
φ <sub>A</sub> (I <sub>sink</sub> = 10 mA)		—	0.25	0.50	
Capacitor C <sub>T</sub> Discharge Current	I <sub>dischg</sub>	20	35	60	mA
Output Pulse Width (Pin 5)	t <sub>PW</sub>	205	225	245	μs

### POWER SUPPLY SECTION

Power Supply Operating Voltage Range (T <sub>A</sub> = - 40° to + 85°C)	V <sub>CC</sub>	5.5	—	V <sub>Z</sub>	V
Power Supply Current	I <sub>CC</sub>	1.8	3.9	5.0	mA
Zener Voltage (I <sub>Z</sub> = 10 mA)	V <sub>Z</sub>	7.5	8.25	9.0	V
Zener Dynamic Impedance (ΔI <sub>Z</sub> = 10 mA to 20 mA, f ≤ 1.0 kHz)	Z <sub>ka</sub>	—	2.0	5.0	Ω

Figure 1. Typical Three Phase, Six Step Motor Application

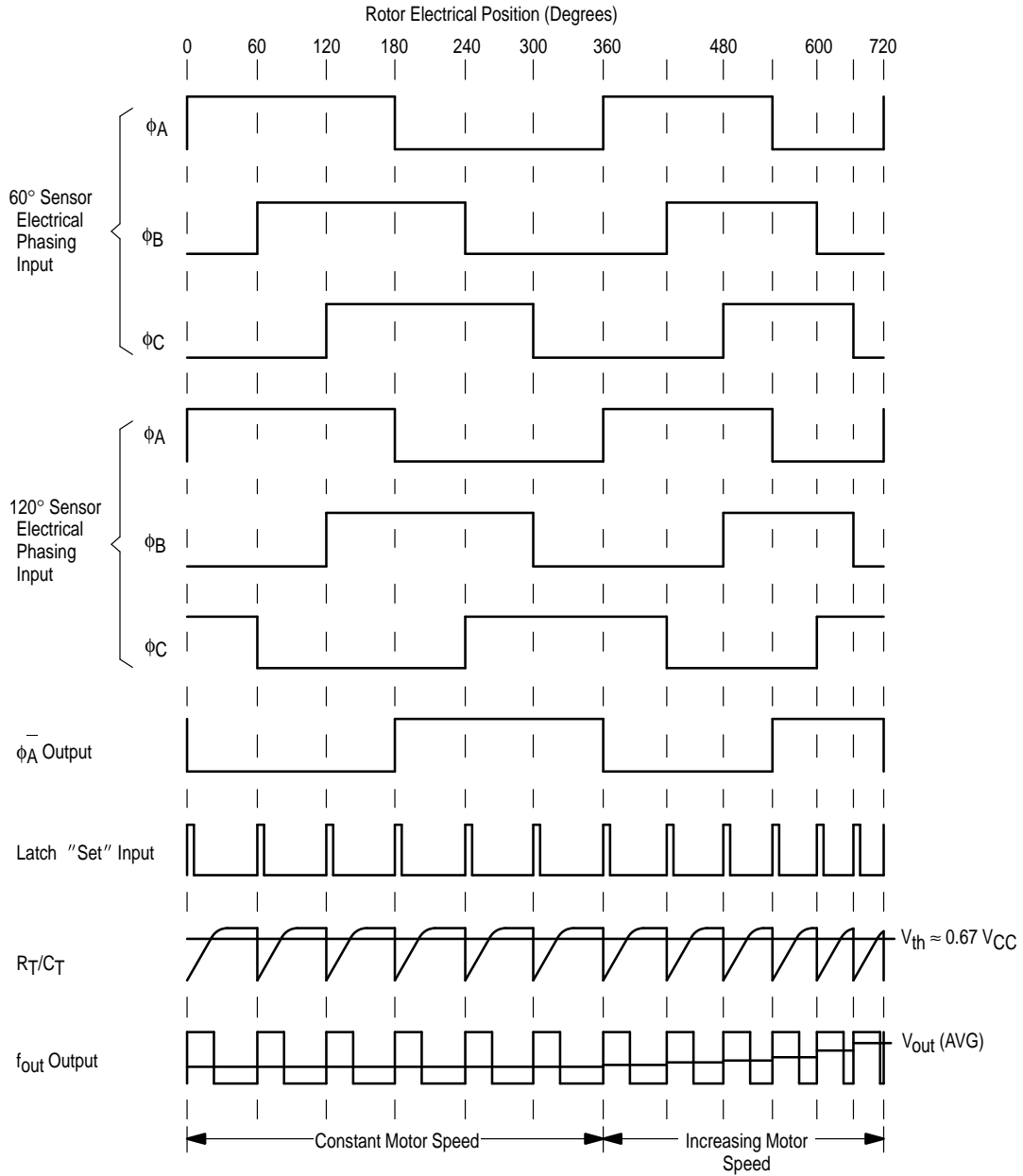

**OPERATING DESCRIPTION**

The MC33039 provides an economical method of implementing closed-loop speed control of brushless DC motors by eliminating the need for a magnetic or optical tachometer. Shown in the timing diagram of Figure 1, the three inputs (Pins 1, 2, 3) monitor the brushless motor rotor position sensors. Each sensor signal transition is digitally detected, OR'ed at the Latch 'Set' Input, and causes  $C_T$  to discharge. A corresponding output pulse is generated at  $f_{out}$  (Pin 5) of a defined amplitude, and programmable width determined by the values selected for  $R_T$  and  $C_T$  (Pin 6). The average voltage of the output pulse train increases with motor speed. When fed through a low pass filter or integrator, a DC voltage proportional to speed is generated. Figure 2 shows the proper connections for a typical closed loop

application using the MC33035 brushless motor controller. Constant speed operation down to 100 RPM is possible with economical three phase four pole motors.

The  $\phi_A$  inverter output (Pin 4) is used in systems where the controller and motor sensor phasing conventions are not compatible. A method of converting from either convention to the other is shown in Figure 3. For a more detailed explanation of this subject, refer to the text above Figure 39 on the MC33035 data sheet.

The output pulse amplitude  $V_{OH}$  is constant with temperature and controlled by the supply voltage on  $V_{CC}$  (Pin 8). Operation down to 5.5 V is guaranteed over temperature. For systems without a regulated power supply, an internal 8.25 V shunt regulator is provided.

# MC33039

Figure 2. Typical Closed Loop Speed Control Application

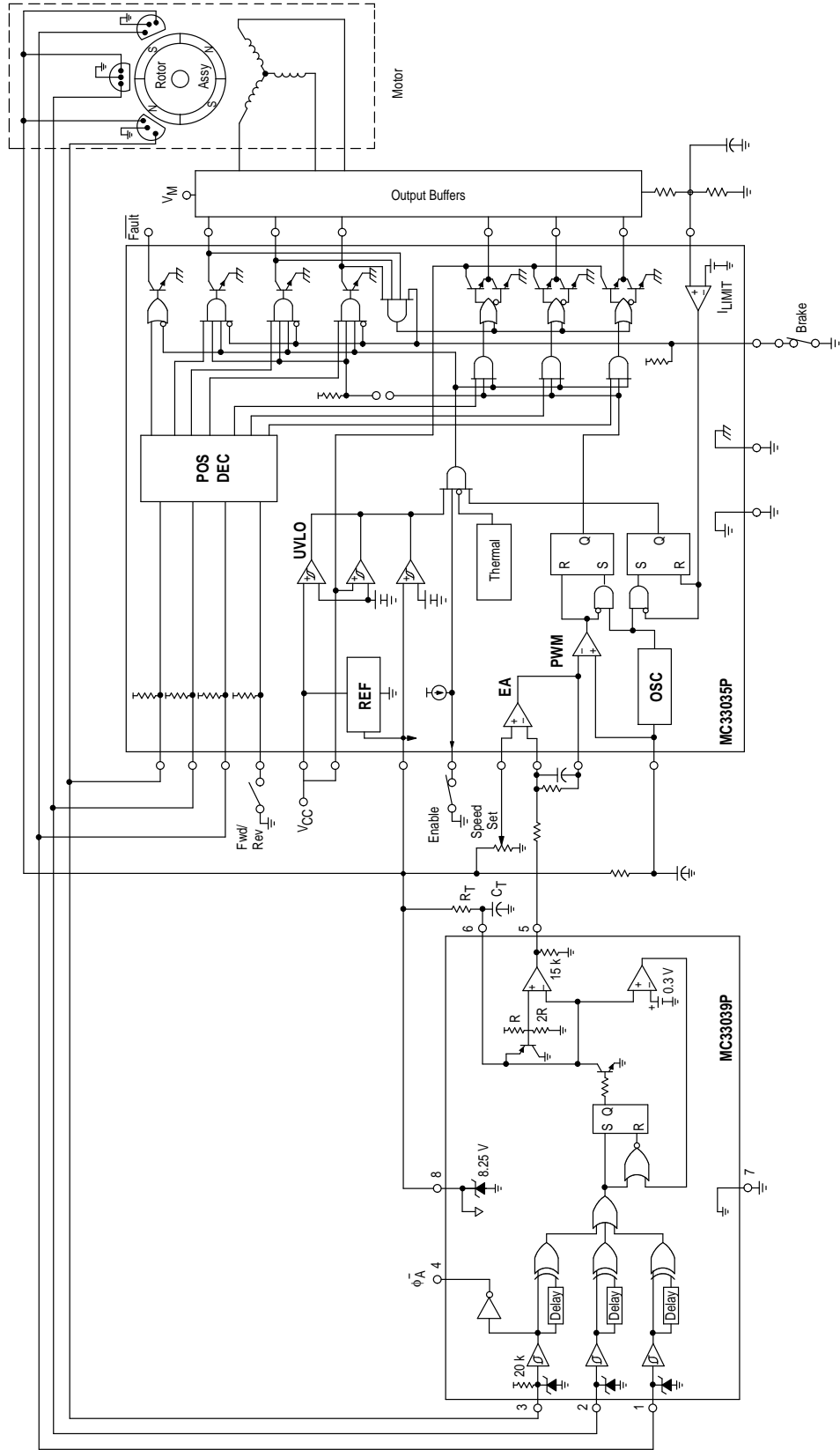

Figure 3.  $f_{out}$ , Pulse Width versus Timing Resistor

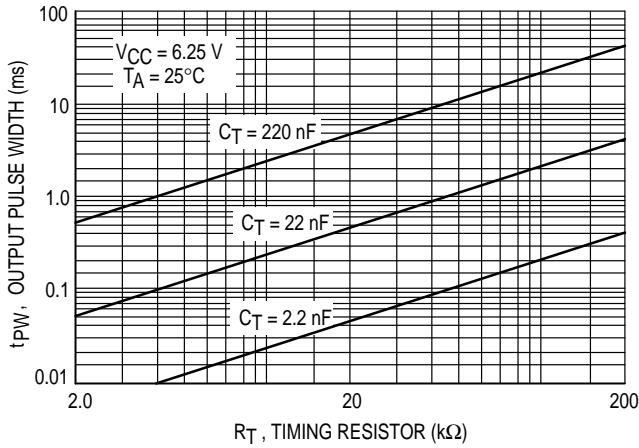

Figure 4.  $f_{out}$ , Pulse Width Change versus Temperature

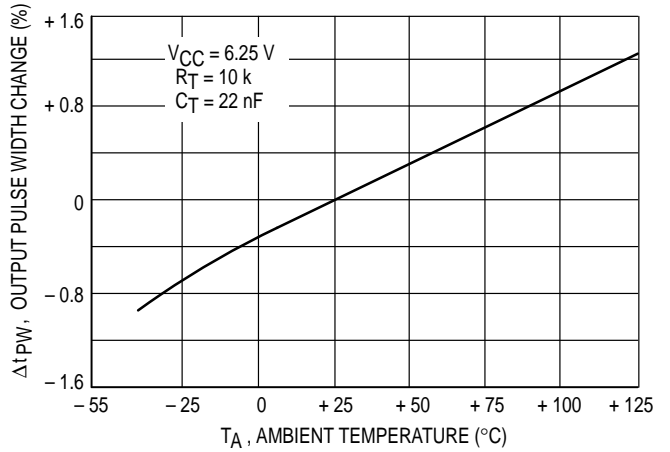

Figure 5.  $f_{out}$ , Pulse Width Change versus Supply Voltage

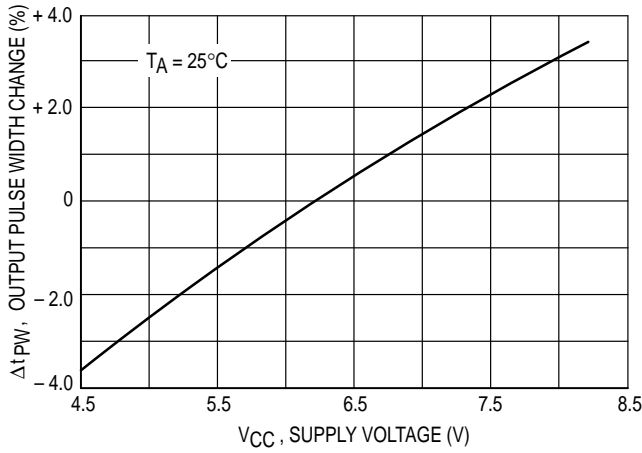

Figure 6. Supply Current versus Supply Voltage

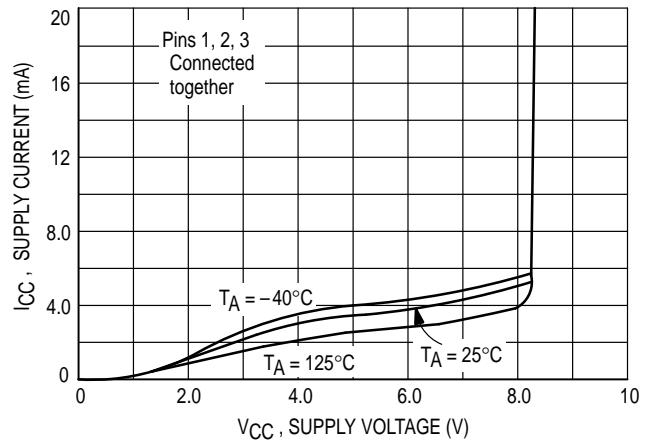

Figure 7.  $f_{out}$ , Saturation versus Load Current

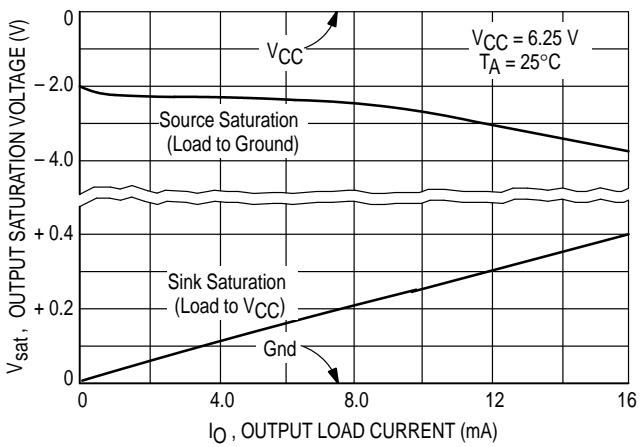
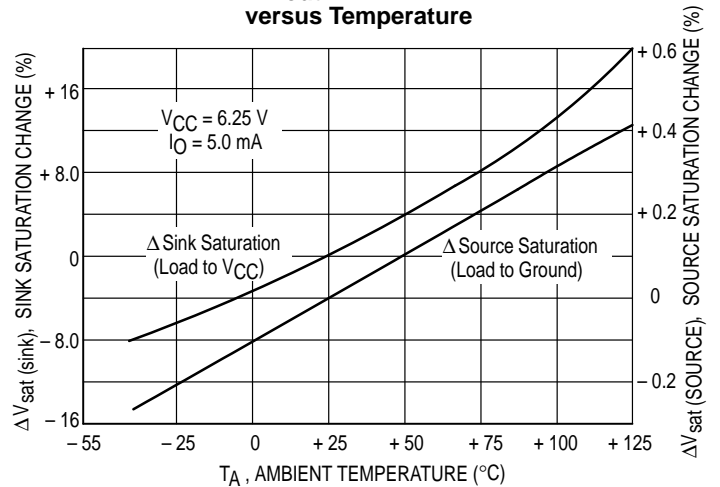

Figure 8.  $f_{out}$ , Saturation Change versus Temperature



# MC33039

## OUTLINE DIMENSIONS

### P SUFFIX PLASTIC PACKAGE CASE 626-05 ISSUE K

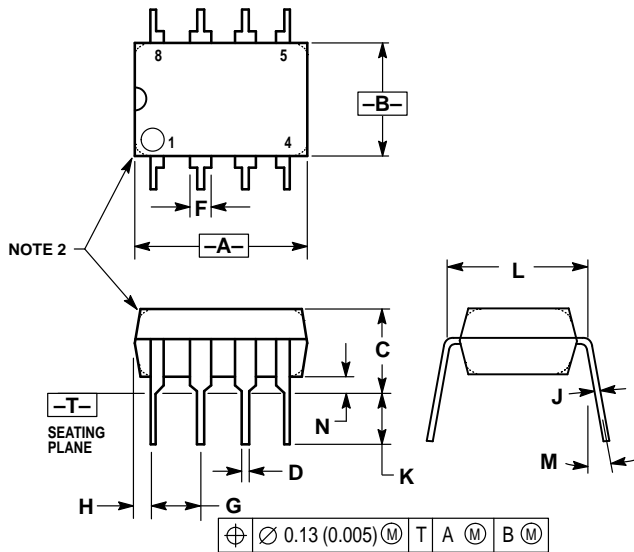

NOTES:

1. DIMENSION L TO CENTER OF LEAD WHEN FORMED PARALLEL.
2. PACKAGE CONTOUR OPTIONAL (ROUND OR SQUARE CORNERS).
3. DIMENSIONING AND TOLERANCING PER ANSI Y14.5M, 1982.

DIM	MILLIMETERS		INCHES	
	MIN	MAX	MIN	MAX
A	9.40	10.16	0.370	0.400
B	6.10	6.60	0.240	0.260
C	3.94	4.45	0.155	0.175
D	0.38	0.51	0.015	0.020
F	1.02	1.78	0.040	0.070
G	2.54 BSC		0.100 BSC	
H	0.76	1.27	0.030	0.050
J	0.20	0.30	0.008	0.012
K	2.92	3.43	0.115	0.135
L	7.62 BSC		0.300 BSC	
M	—		10°	
N	0.76	1.01	0.030	0.040

### D SUFFIX PLASTIC PACKAGE CASE 751-05 ISSUE N (SO-8)

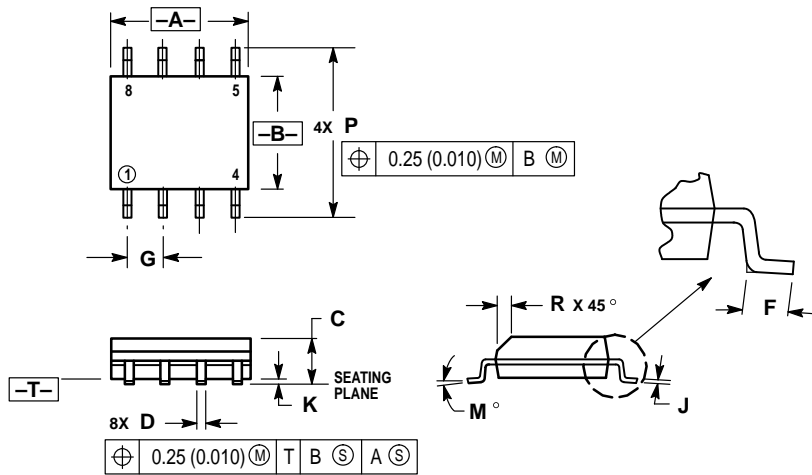

NOTES:

1. DIMENSIONING AND TOLERANCING PER ANSI Y14.5M, 1982.
2. CONTROLLING DIMENSION: MILLIMETER.
3. DIMENSIONS A AND B DO NOT INCLUDE MOLD PROTRUSION.
4. MAXIMUM MOLD PROTRUSION 0.15 (0.006) PER SIDE.
5. DIMENSION D DOES NOT INCLUDE DAMBAR PROTRUSION. ALLOWABLE DAMBAR PROTRUSION SHALL BE 0.127 (0.005) TOTAL IN EXCESS OF THE D DIMENSION AT MAXIMUM MATERIAL CONDITION.

DIM	MILLIMETERS		INCHES	
	MIN	MAX	MIN	MAX
A	4.80	5.00	0.189	0.196
B	3.80	4.00	0.150	0.157
C	1.35	1.75	0.054	0.068
D	0.35	0.49	0.014	0.019
F	0.40	1.25	0.016	0.049
G	1.27 BSC		0.050 BSC	
J	0.18	0.25	0.007	0.009
K	0.10	0.25	0.004	0.009
M	0°		7°	
P	5.80	6.20	0.229	0.244
R	0.25	0.50	0.010	0.019

Motorola reserves the right to make changes without further notice to any products herein. Motorola makes no warranty, representation or guarantee regarding the suitability of its products for any particular purpose, nor does Motorola assume any liability arising out of the application or use of any product or circuit, and specifically disclaims any and all liability, including without limitation consequential or incidental damages. "Typical" parameters which may be provided in Motorola data sheets and/or specifications can and do vary in different applications and actual performance may vary over time. All operating parameters, including "Typicals" must be validated for each customer application by customer's technical experts. Motorola does not convey any license under its patent rights nor the rights of others. Motorola products are not designed, intended, or authorized for use as components in systems intended for surgical implant into the body, or other applications intended to support or sustain life, or for any other application in which the failure of the Motorola product could create a situation where personal injury or death may occur. Should Buyer purchase or use Motorola products for any such unintended or unauthorized application, Buyer shall indemnify and hold Motorola and its officers, employees, subsidiaries, affiliates, and distributors harmless against all claims, costs, damages, and expenses, and reasonable attorney fees arising out of, directly or indirectly, any claim of personal injury or death associated with such unintended or unauthorized use, even if such claim alleges that Motorola was negligent regarding the design or manufacture of the part. Motorola and  are registered trademarks of Motorola, Inc. Motorola, Inc. is an Equal Opportunity/Affirmative Action Employer.

# MC33039

Mfax is a trademark of Motorola, Inc.

**How to reach us:**

**USA/EUROPE/Locations Not Listed:** Motorola Literature Distribution;  
P.O. Box 5405, Denver, Colorado 80217. 303-675-2140 or 1-800-441-2447

**JAPAN:** Nippon Motorola Ltd.: SPD, Strategic Planning Office, 4-32-1,  
Nishi-Gotanda, Shinagawa-ku, Tokyo 141, Japan. 81-3-5487-8488

**Mfax™:** RMFAX0@email.sps.mot.com – TOUCHTONE 602-244-6609  
– US & Canada ONLY 1-800-774-1848

**ASIA/PACIFIC:** Motorola Semiconductors H.K. Ltd.; 8B Tai Ping Industrial Park,  
51 Ting Kok Road, Tai Po, N.T., Hong Kong. 852-26629298

**INTERNET:** <http://motorola.com/sps>



**MOTOROLA**



---

MC33039/D



This datasheet has been download from:

[www.datasheetcatalog.com](http://www.datasheetcatalog.com)

Datasheets for electronics components.